

Level "A" POD

"Sample Patient Flow"

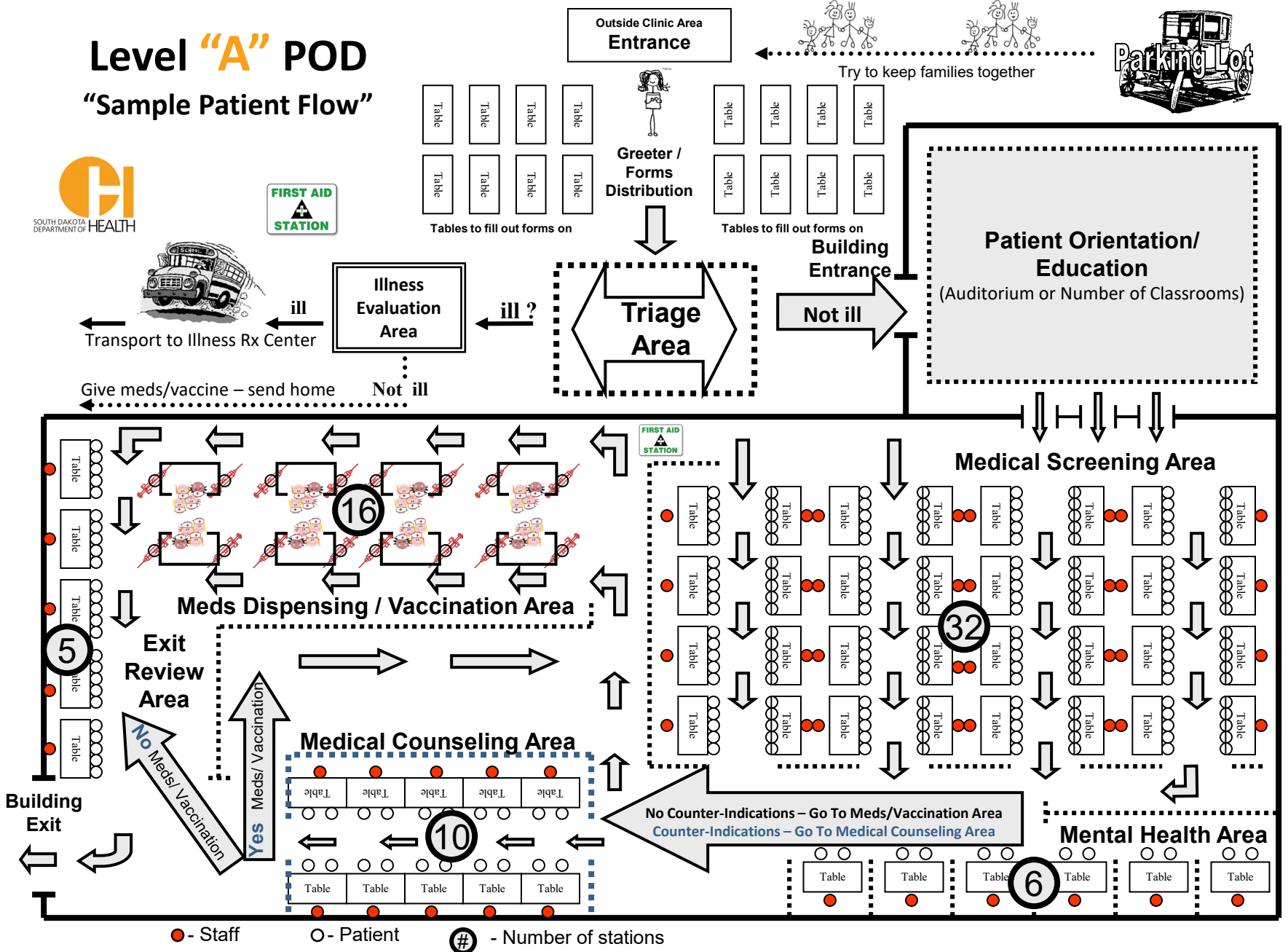

Level "B" POD

"Sample Patient Flow"



Outside Clinic Area
Entrance

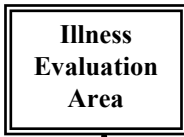
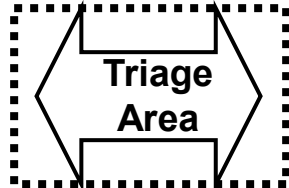
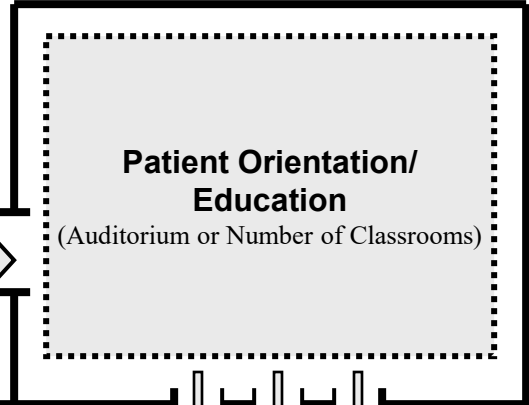
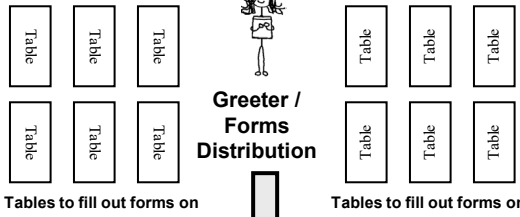
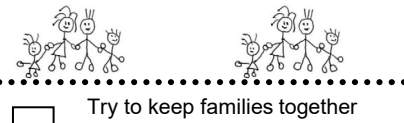

Transport to Illness Rx Center

ill

Give meds/vaccine – send home

Not ill

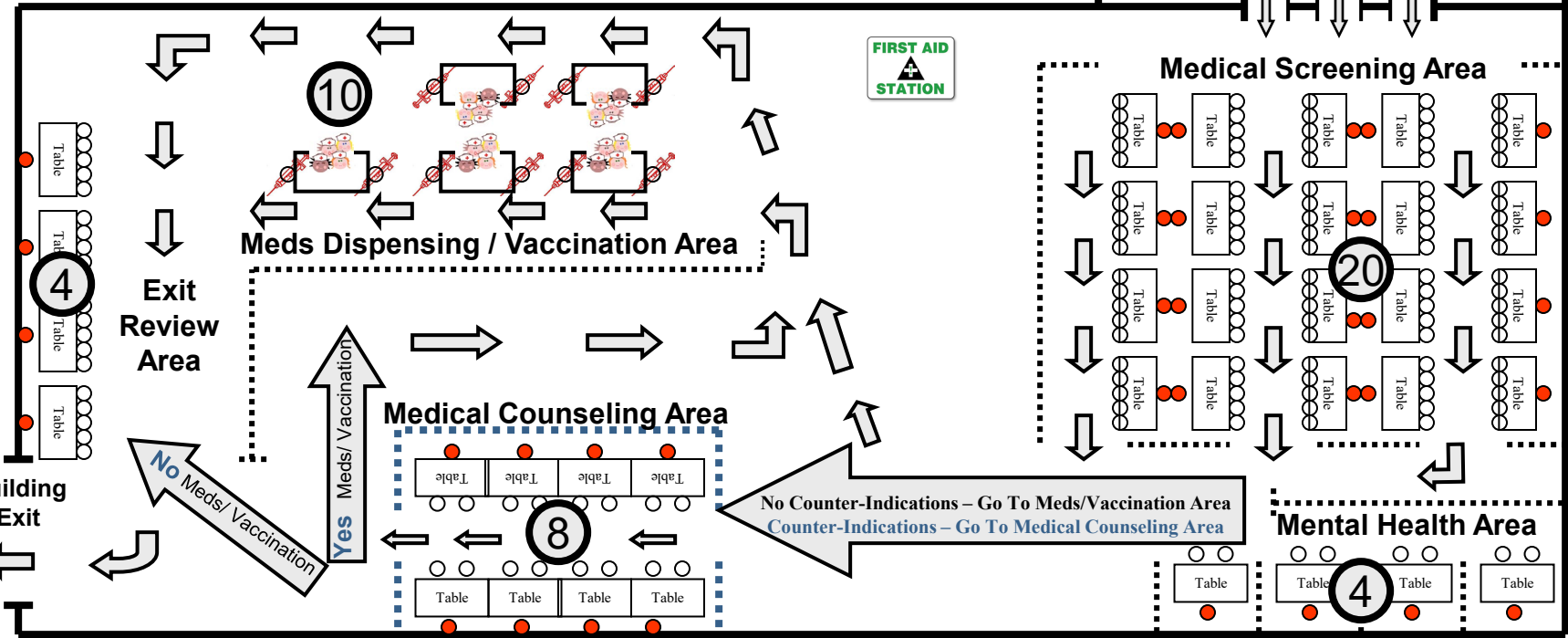

● - Staff ○ - Patient # - Number of stations

Level "C" POD

"Sample Patient Flow"



Outside Clinic Area
Entrance

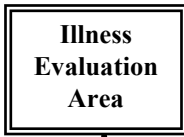
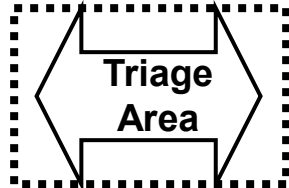
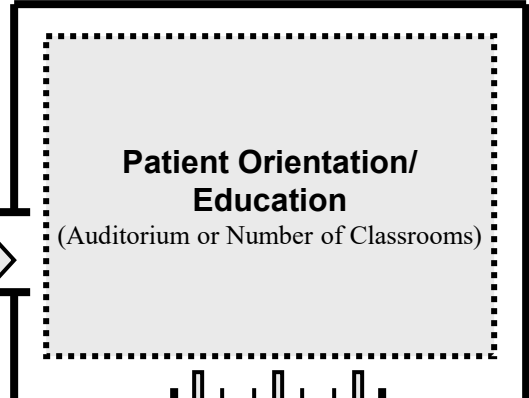
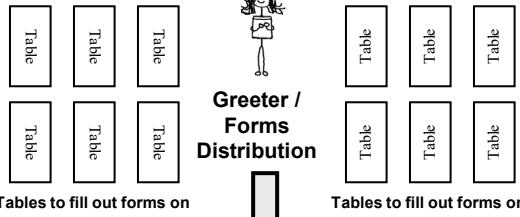
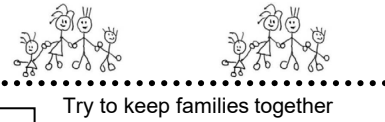

Transport to Illness Rx Center

ill

Give meds/vaccine – send home

Not ill

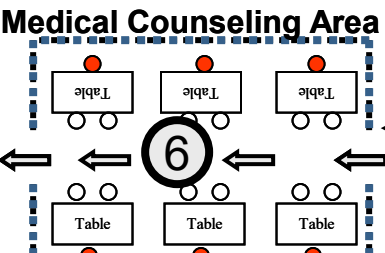
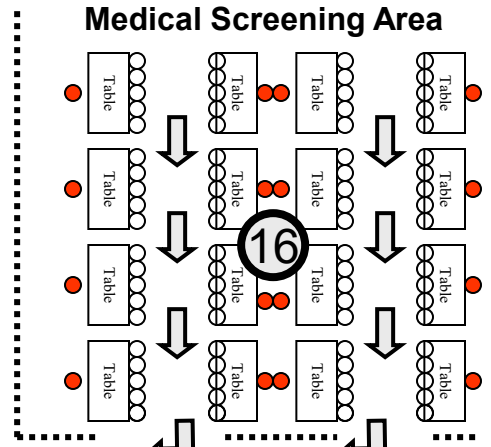
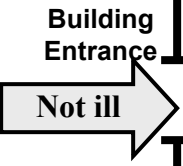

No Counter-Indications – Go To Meds/Vaccination Area

Counter-Indications – Go To Medical Counseling Area

Building Exit

● - Staff ○ - Patient # - Number of stations

Level "D" POD

"Sample Patient Flow"



Outside Clinic Area
Entrance

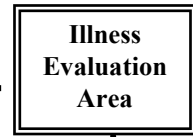
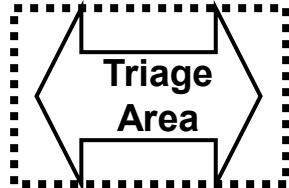
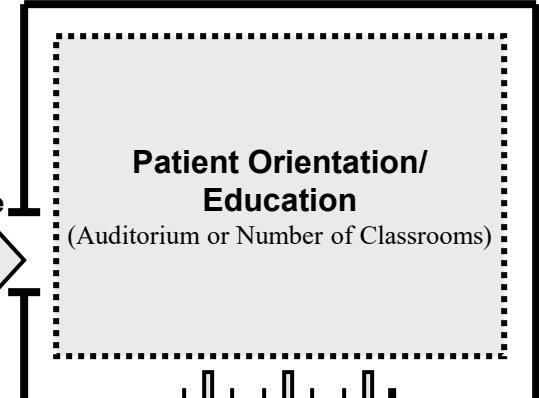
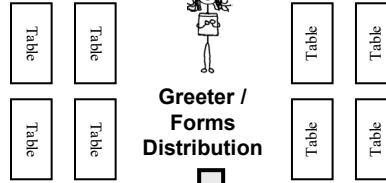
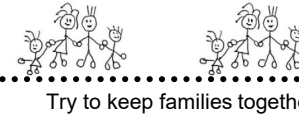

Transport to Illness Rx Center

ill

Give meds/vaccine – send home

Not ill

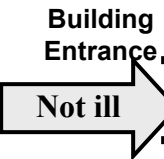

Meds Dispensing / Vaccination Area



Medical Screening Area

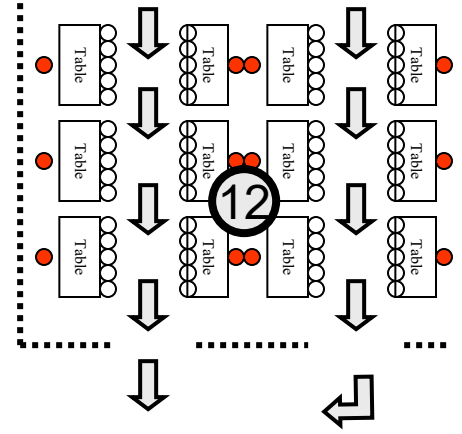

Exit Review Area

2

Medical Counseling Area

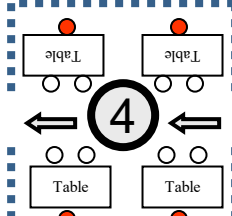

No Counter-Indications – Go To Meds/Vaccination Area
Counter-Indications – Go To Medical Counseling Area

Mental Health Area

2

Building Exit

● - Staff ○ - Patient # - Number of stations